

**MT. DIABLO UNIFIED SCHOOL DISTRICT
BOARD OF EDUCATION**

Resolution No. 12-13-22

**RESOLUTION OF DEDICATION OF EASEMENT
COLLEGE PARK HIGH SCHOOL**

WHEREAS, section 17556 of the Education Code authorizes the Mt. Diablo Unified School District (“District”) to dedicate or convey an easement to any public entity or public utility, with or without consideration and without a vote of the electors of the District; and

WHEREAS, Contra Costa Water District, a public entity (“Grantee”), has requested that the District, a California public school district, dedicate to it a non-exclusive, permanent and non-assignable easement for the use of certain real property more specifically described in Exhibits A,B and C attached hereto (“Easement”), for the following purposes:

Connecting a dedicated fire protection line (hydrant) and associated equipment

WHEREAS, the proposed easement will provide benefit to the District; and

WHEREAS, on November 5, 2012, the Board of Trustees of the District (the “Board”) adopted a Resolution of Dedication of an easement to the Grantee as required by section 17557 of the Education Code; and

WHEREAS, the notice of the Board’s intent to dedicate an easement of real property to the Grantee was given as required by section 17558 of the Education Code; and

WHEREAS, a public hearing was held on December 10, at 7:30 p.m., at 1936 Carlotta Drive, Concord, CA as required by section 17556 of the Education Code;

NOW THEREFORE, BE IT RESOLVED by the Board that the Board finds and determines that:

1. The foregoing recitals are true.
2. Dedication of the Easement described in the deed attached hereto as Exhibit “C” is in the best interest of the District.

RESOLUTION NO. _____

Page Two

BE IT FURTHER RESOLVED that the Board authorizes the Superintendent or designee to convey the Easement from the District to the Grantee by the execution and delivery to Contra Costa water District or its agent of an easement deed in the form set forth in Exhibit C hereto within fifteen (15) days after adoption of this resolution and to take all other actions necessary to dedicate the Easement and deliver the Deed to the Grantee.

ADOPTED, SIGNED and APPROVED on _____, 2012

President, Board of Education

I, _____, Secretary of the Board of Education of the Mount Diablo Unified School District, do hereby certify that the foregoing Resolution was adopted by the Board of Education of the District by a two-thirds vote or more at a meeting of the Board held on _____, 2012, and that it was adopted by the following votes:

AYES

NOES

ABSTAIN

ABSENT

Secretary, Board of Education

EXHIBIT "A"
LEGAL DESCRIPTION
CONTRA COSTA WATER DISTRICT WATERLINE EASEMENT

EASEMENT for waterline purposes, installation and ingress and egress thereto, over, upon and across real property situate in the City of Pleasant Hill, Contra Costa County, State of California, described as follows:

A portion of that parcel of land granted to the Mt. Diablo Unified School District of Contra Costa County as described in the Grant Deed recorded in Book 2787 of Official Records, Page 510, more particularly described as follows:

COMMENCING at the northwesterly corner of the parcel of land described in the deed to Contra Costa County recorded January 19, 1959, in Book 3302, Official Records of Contra Costa County, at Page 285; thence along the north line of said parcel (2787 OR 510), South 89°39'16" West, 696.78 feet to the **POINT OF BEGINNING**; thence continuing along the north line of said parcel, South 89°39'16" West, 15.00 feet; thence at a right angle, South 00°20'44" East, 50.00 feet; thence at a right angle, North 89°39'16" East, 15.00 feet; thence at a right angle, North 00°20'44" West, 50.00 feet to the **POINT OF BEGINNING**

CONTAINING 750 square feet, more or less.

Prepared by **Luk and Associates**

Jacqueline Luk, PLS 8934

Date: _____

This real property description has been prepared by me or under my direction in conformance with the Professional Land Surveyors Act.



C.C. JR. COLLEGE
DISTRICT
APN 153-040-009
BK 1669 PG 403

VIKING DRIVE

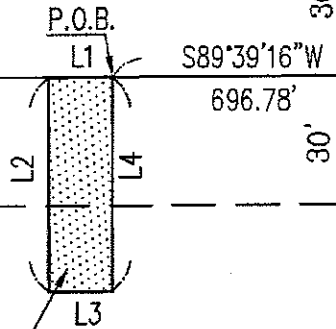

WATERLINE EASEMENT
AREA = 750 S.F.±

P.O.C.

S89°39'16"W
696.78'



VIKING DRIVE EXTENSION
CONTRA COSTA COUNTY
BK 3302 PG 285

VALLEY VIEW
MIDDLE SCHOOL

MT. DIABLO UNIFIED
SCHOOL DISTRICT
APN 153-040-005
BK 2787 PG 510

LINE TABLE		
LINE	LENGTH	BEARING
L1	15.00'	S89°39'16"W
L2	50.00'	S00°20'44"E
L3	15.00'	N89°39'16"E
L4	50.00'	N00°20'44"W

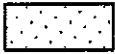
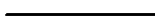
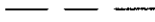
LEGEND

- P.O.C. POINT OF COMMENCEMENT
- P.O.B. POINT OF BEGINNING
- S.F.± SQUARE FEET
- BK PG BOOK AND PAGE
- APN ASSESSOR'S PARCEL NUMBER
-  PROPOSED WATERLINE EASEMENT
-  RIGHT-OF-WAY LINE
-  OLD LOT LINE
-  CENTERLINE
-  EASEMENT LINE

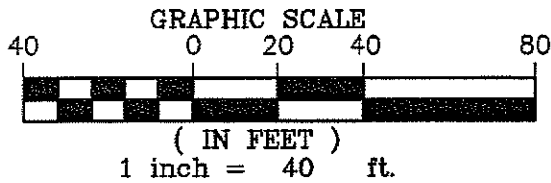
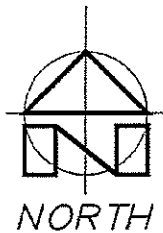

Prepared By
Luk and Associates
Civil Engineers - Land Planners - Land Surveyors
738 Alfred Nobel Drive
Hercules, California 94547

EXHIBIT "B"
CONTRA COSTA WATER DISTRICT
WATERLINE EASEMENT
PLAT TO ACCOMPANY LEGAL DESCRIPTION
COLLEGE PARK HIGH SCHOOL - 201 VIKING DRIVE
PLEASANT HILL - CONTRA COSTA COUNTY - CALIFORNIA
OCTOBER 2012 SCALE: 1"=10'

CCWD-ESMT.TXT

Lot name: CCWD-ESMT

North: 2177962.1968	East: 6108800.8672
Line Course: S 89-39-16 W Length: 15.00	
North: 2177962.1063	East: 6108785.8675
Line Course: S 00-20-44 E Length: 50.00	
North: 2177912.1072	East: 6108786.1690
Line Course: N 89-39-16 E Length: 15.00	
North: 2177912.1977	East: 6108801.1688
Line Course: N 00-20-44 W Length: 50.00	
North: 2177962.1968	East: 6108800.8672

Perimeter: 130.00 Area: 750 sq.ft. 0.02 acres

Mapcheck Closure - (Uses listed courses, radii, and deltas)
Error Closure: 0.0000 Course: S 90-00-00 E
Error North: 0.00000 East: 0.00000
Precision 1: 130,000,000.00

EASEMENT AGREEMENT

THIS AGREEMENT AND GRANT OF EASEMENT is made by and between

hereinafter called "the Grantor", and CONTRA COSTA WATER DISTRICT, a local governmental agency of the State of California, hereinafter called "the District".

1. For valuable consideration, the Grantor hereby grants to the District and the District hereby accepts from the Grantor, a perpetual easement in the real property in the County of Contra Costa, State of California, described on Exhibit A and delineated on Exhibit B attached.

2. The purpose of this easement is to install, operate, maintain, repair and replace water utility materials and equipment, including, without limitation; pipes, valves, meters, meter boxes, fire hydrants, protecting posts, rectifiers, power line poles and guys, air releases, blow-offs, backflow prevention devices and appurtenances.

3. All pipes except risers to meters, fire hydrants or appurtenances shall be installed at least 18 inches below the surface of the ground.

4. The District will backfill all excavations and restore the ground to a condition equal to the condition existing prior to the excavation.

5. The Grantor will not permit any structure to be placed on the easement or the access thereto which will prevent vehicles and equipment from operating anywhere within the easement.

IN WITNESS WHEREOF, the Grantor and the District executed this agreement and grant of easement on

Date

Print Name of Company, Corporation, Individual

"Grantor"

Print or Type Name

"Grantor"

Print or Type Name

CONTRA COSTA WATER DISTRICT

By _____

"District"
Stephen J. Welch, Assistant General Manager

CERTIFICATE OF ACCEPTANCE

This is to certify that the interest in real property conveyed by the foregoing instrument to Contra Costa Water District, a local governmental agency, is hereby accepted by the undersigned officer on behalf of the Board of Directors of the District pursuant to authority conferred by the Board's Resolution No. 93-29 and the grantee consents to recordation thereof by its duly authorized officer.

Dated: _____ By _____
Stephen J. Welch, Assistant General Manager

RECORDING REQUESTED BY AND
WHEN RECORDED, MAIL TO:

Contra Costa Water District
P.O. Box H20
Concord, CA 94524

SPACE ABOVE THIS LINE FOR RECORDERS' USE

APN:

District Site: College Park High School
201 Viking Drive
Pleasant Hill, CA 94523-1809

EASEMENT DEED

FOR A VALUABLE CONSIDERATION, receipt of which is hereby acknowledged,

MT. DIABLO UNIFIED SCHOOL DISTRICT, a California public school district ("District"), hereby grants to Contra Costa Water District, organized under the laws of the State of California ("Grantee"),

A non-exclusive easement for operational and maintenance purposes and incidents thereto under, upon, over and across the land in the City of Pleasant Hill, County of Contra Costa, State of California, described as follows:

See Exhibits "A," "B" and "C" attached hereto and made a part hereof ("Easement"),

subject to the terms and conditions indicated below:

1. Grantee, at no expense to District, shall obtain from all agencies or authorities with jurisdiction any and all required permits, inspections, or similar approvals that may be required for any and all activities Grantee conducts on the Easement, including construction of roadway and drainage improvements.
2. Grantee, in the use, upkeep, and maintenance of the Easement, shall conform to all pertinent laws, ordinances, rules and regulations.
3. Grantee, at no expense to District, shall maintain in good and safe condition the Easement and the facilities and improvements installed by Grantee within the Easement. [Grantee shall notify the District Department of Maintenance at least twenty-four (24) hours in advance if maintenance activity necessitates access across District property.]
4. Grantee shall not sell, convey, assign, or transfer the Easement to any other entity or person, without the written consent of the District.
5. District may terminate the Easement immediately upon written notice after any of the following events: any violation by Grantee of any law, rule, regulation or ordinance, including District rules and regulations that are pertinent to the construction, operation, maintenance and repair of the Easement.

The Easement shall automatically and immediately terminate when and if Grantee no longer uses or maintains the Easement. Upon termination of the Easement, Grantee shall cease all use of the Easement and shall immediately reconvey the Easement to District by execution of a quitclaim deed to District.

6. To the fullest extent permitted by California law, Grantee shall defend, indemnify, and hold harmless District, its agents, representatives, officers, consultants, employees, trustees, and volunteers (indemnified parties) from any and all demands, losses, liabilities, claims, suits, and actions (claims) of any kind, nature, and description, including, but not limited to, attorneys' fees and costs, directly or indirectly arising from personal or bodily injuries, death, property damage, or otherwise arising out of, connected with, or resulting from the District's dedication of the Easement to Grantee, or from any activity, work, or thing done, permitted, or suffered by Grantee in conjunction with the Easement, except to the extent the claims are caused by the sole negligence or willful misconduct of the indemnified parties. District shall have the right to accept or reject any legal counsel that Grantee proposes to defend District.

Dated: _____, 2012.

MT. DIABLO UNIFIED SCHOOL DISTRICT

By: _____

Print Name: _____

Print Title: _____

STATE OF CALIFORNIA,

COUNTY OF _____

Subscribed before me, the undersigned, a Notary Public in and for

said State, by _____ personally
appeared _____

personally known to me (or proved to me on the basis of satisfactory evidence) to be the person(s) whose name(s) is/are subscribed to the within instrument and acknowledged to me that he/she/they executed the same in his/her/their authorized capacity(ies), and that by his/her/their signature(s) on the instrument the person(s) or the entity on behalf of which the person(s) acted, executed the instrument.

WITNESS my hand and official seal.

Signature _____

(Apply official notarial seal)